

TRACK 2

BATTLE AT THE PALACE

OPPONENT'S PERFORMANCE

[] []

[] []

TRACK 4

HALLOWEEN ON FIRE

[] []

[] []

[] []



TRACK 3

DEBUT UNDER THE RAINBOW

[] []

[] []

[] []

[] []

[] []

TRACK 5

STARS AT STARLITE

[] []

[] []

[] []

[] []

[] []

[] []

[] []

TURN ON THE VOLTAGE

TRACK 5

A gig grid for the track 'Turn On the Voltage'. It consists of 11 slots arranged in three rows. Each slot contains a '#' symbol, a circle, and a square. The first row has three slots with a club location pin above the first, a diamond location pin to the left of the first, and a star above the third. The second row has two slots with a club location pin above the first. The third row has three slots with a heart location pin above the first, a band icon below the second, and a star above the third. To the right of the third row is an 'ENCORE' slot with a '#' symbol, a circle, a square, and a band icon below it.

CHARITY IN SPACE

TRACK 5

A gig grid for the track 'Charity in Space'. It consists of four slots in a single row. Each slot contains a '#' symbol, a circle, and a square. The first slot has a club location pin above it. The second slot has a band icon below it. The third slot has a band icon below it. The fourth slot has a star above it and a band icon below it.

ROCK THE MAIDEN

TRACK 5

A gig grid for the track 'Rock the Maiden'. It consists of four slots in a single row. Each slot contains a '#' symbol, a circle, and a square. The first slot has a club location pin above it and a diamond location pin to its left. The second slot has a star above it and a band icon below it. The third slot has a heart location pin above it and a band icon below it. The fourth slot has a band icon below it.

DOWN THE DUNGEON

TRACK 5

A gig grid for the track 'Down the Dungeon'. It consists of 11 slots arranged in three rows. Each slot contains a '#' symbol, a circle, and a square. The first row has three slots with a club location pin above the first and a '1' location pin above the third. The second row has three slots with a diamond location pin above the first, a heart location pin to its left, and a '2' location pin above the third. The third row has one slot with a star above it and an 'ENCORE' label above the slot. The 'ENCORE' slot contains a '#' symbol, a circle, a square, and a band icon below it.

A single slot containing a '#' symbol, a circle, and a square. It has a heart location pin above it and a band icon below it.

A single slot containing a '#' symbol, a circle, and a square. It has a star above it and a band icon below it.

A single slot containing a '#' symbol, a circle, and a square. It has a band icon below it.

An 'ENCORE' slot containing a '#' symbol, a circle, a square, and a band icon below it.

METAL HEROES

GIG GRIDS
PAGE 3

BONUS 1

SWEDISH SINS

A gig grid for 'SWEDISH SINS' consisting of 12 slots arranged in two columns. The top row has three slots: the first has a club icon, the second has a dice icon, and the third has a spade icon. The middle row has three slots: the first has a heart icon, the second is empty, and the third has a star icon. The bottom row has two slots: the first has a plus icon, and the second is labeled 'ENCORE' with a star icon. Each slot contains a '#' symbol, a circle, and a square box for notes.

BONUS 1

GIG FOR ZIG

A gig grid for 'GIG FOR ZIG' consisting of four slots in a single row. The first three slots are empty, and the fourth has a plus icon. Each slot contains a '#' symbol, a circle, and a square box for notes.

OPEN AIR ÖSTERSUND

BONUS 1

A gig grid for 'OPEN AIR ÖSTERSUND' consisting of 12 slots arranged in two columns. The top row has three slots: the first has a club icon, the second is empty, and the third has a spade icon. The middle row has four slots: the first has a heart icon, the second has a star icon, the third is empty, and the fourth has a plus icon. The bottom row has three slots: the first has a heart icon, the second is empty, and the third has a star icon. Each slot contains a '#' symbol, a circle, and a square box for notes.

TRACK 6

VAMP THE MANSION

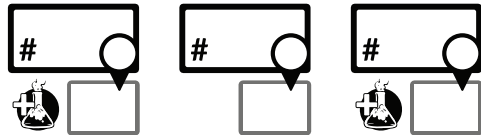

TRACK 7

BRAVE HEROES

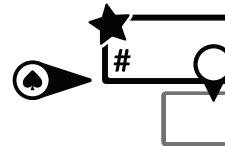
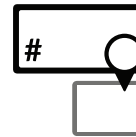
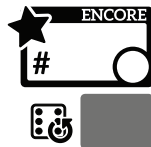
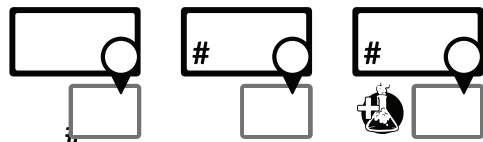

TRACK 7
BRING IT TO THE MAX

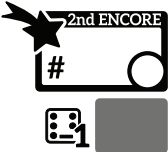
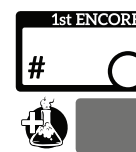
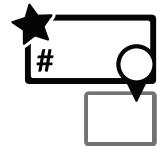
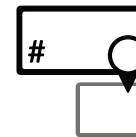
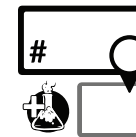
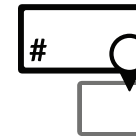
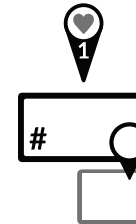

TRACK 7

UNDERWORLD PREVIEW

TRACK 8

METAL METRO MAYHEM

W:O:A HEADBANGER STAGE

TRACK 8

W:O:A TV-GIG TRACK 8

ROCK THE BOAT TRACK 9

TRACK 10

INTRODUCING THE HALL

Star icon, #, circle, dice icon with 1, square

TRACK 10

MBRO AWARDS MEDLEY

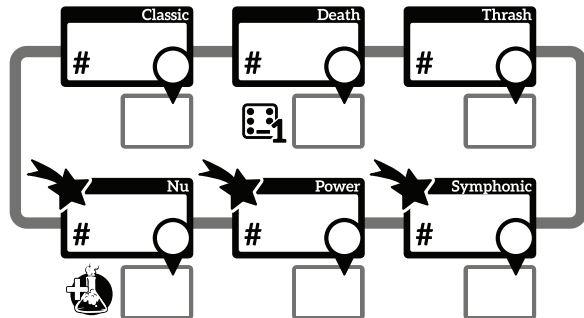

BONUS 3

ECHO ROSSIJA

Grid of 12 boxes for Echo Rossiya. Each box contains a #, a circle, and a square. Includes various icons: ♣1, ♠1, ♠2, ♠3, ♠4, ♠5, ♠6, ♠7, ♠8, ♠9, ♠10, ♠11, ♠12, ♠13, ♠14, ♠15, ♠16, ♠17, ♠18, ♠19, ♠20, ♠21, ♠22, ♠23, ♠24, ♠25, ♠26, ♠27, ♠28, ♠29, ♠30, ♠31, ♠32, ♠33, ♠34, ♠35, ♠36, ♠37, ♠38, ♠39, ♠40, ♠41, ♠42, ♠43, ♠44, ♠45, ♠46, ♠47, ♠48, ♠49, ♠50, ♠51, ♠52, ♠53, ♠54, ♠55, ♠56, ♠57, ♠58, ♠59, ♠60, ♠61, ♠62, ♠63, ♠64, ♠65, ♠66, ♠67, ♠68, ♠69, ♠70, ♠71, ♠72, ♠73, ♠74, ♠75, ♠76, ♠77, ♠78, ♠79, ♠80, ♠81, ♠82, ♠83, ♠84, ♠85, ♠86, ♠87, ♠88, ♠89, ♠90, ♠91, ♠92, ♠93, ♠94, ♠95, ♠96, ♠97, ♠98, ♠99, ♠100.

1st ENCORE and 2nd ENCORE boxes. Each contains a #, a circle, and a square. Includes star icon and band icon.

BONUS 3

SÃO PAULO ARENA

FINAL

INFERNO IN THE DEEP

A gig grid for São Paulo Arena consisting of 20 slots arranged in 5 rows and 4 columns. The slots are represented by boxes with a '#' and a circle. Various icons are placed around the grid: a club icon with '1' above the top-left slot, a heart icon with '1' to the left of the second slot, a star above the third slot, a spade icon with '2' above the fourth slot, a diamond icon with '1' to the left of the fifth slot, a heart icon with '2' to the left of the sixth slot, a spade icon with '1' to the left of the seventh slot, a club icon with '2' to the left of the eighth slot, a diamond icon with '2' to the left of the ninth slot, and a star above the tenth slot. At the bottom, three 'ENCORE' slots are shown, labeled '1st ENCORE', '2nd ENCORE', and '3rd ENCORE', with arrows pointing to the 10th, 11th, and 12th slots respectively. A wheelchair icon is present in the bottom-left slot.

1ST SONG

1ST SET

A gig grid for Inferno in the Deep consisting of 17 slots arranged in 5 rows and 3 columns. The slots are represented by boxes with a '#' and a circle. The grid is divided into sections: '1ST SONG' (top-left), '1ST SET' (top-right, labeled 'Death'), '2ND SET' (middle, labeled 'Thrash'), and 'FINAL SET' (bottom). Numbered callouts (12-17) point to specific slots. A wheelchair icon is present in the bottom-left slot.