

TRACK 2

BATTLE AT THE PALACE

OPPONENT'S PERFORMANCE

#

#

TRACK 4

HALLOWEEN ON FIRE

#

#

#



TRACK 3

DEBUT UNDER THE RAINBOW

#

#

#

#

#

TRACK 5

STARS AT STARLITE

#

#

#

#

#

#

#

TURN ON THE VOLTAGE

TRACK 5

A 3x4 grid of boxes for the song 'Turn On the Voltage'. Each box contains a '#' and a circle. The boxes are decorated with various icons: a club, a diamond, a heart, a star, and a band icon. The bottom-right box is labeled 'ENCORE' and has a grey square next to it.

CHARITY IN SPACE

TRACK 5

A 1x4 grid of boxes for the song 'Charity in Space'. Each box contains a '#' and a circle. The boxes are decorated with a club, a diamond, a heart, and a star. The third box has a band icon below it.

ROCK THE MAIDEN

TRACK 5

A 1x4 grid of boxes for the song 'Rock the Maiden'. Each box contains a '#' and a circle. The boxes are decorated with a club, a diamond, a heart, and a star. The second box has two location pins above it, and the fourth box has a band icon below it.

DOWN THE DUNGEON

TRACK 5

A 3x4 grid of boxes for the song 'Down the Dungeon'. Each box contains a '#' and a circle. The boxes are decorated with a club, a diamond, a heart, a star, and location pins numbered 1 and 2. The bottom-right box is labeled 'ENCORE' and has a grey square next to it.

A 3x2 grid of boxes for the song 'Rock the Maiden'. Each box contains a '#' and a circle. The boxes are decorated with a heart, a star, and a band icon. The bottom-right box is labeled 'ENCORE' and has a grey square next to it.

METAL HEROES

GIG GRIDS
PAGE 3

BONUS 1

SWEDISH SINS

A gig grid for 'SWEDISH SINS' consisting of 12 slots arranged in three columns. Each slot contains a '#' symbol, a circle with a dot, and a square box below. The grid includes several icons: a club symbol, a spade symbol, a diamond symbol, a heart symbol, a star, and a figure with a cross. The bottom right slot is labeled 'ENCORE' and has a grey square below it.

BONUS 1

GIG FOR ZIG

A gig grid for 'GIG FOR ZIG' consisting of 4 slots in a single row. Each slot contains a '#' symbol, a circle with a dot, and a square box below. The rightmost slot includes a figure with a cross icon.





OPEN AIR ÖSTERSUND







BONUS 1

A gig grid for 'OPEN AIR ÖSTERSUND' consisting of 12 slots arranged in three columns. Each slot contains a '#' symbol, a circle with a dot, and a square box below. The grid includes several icons: a club symbol, a spade symbol, a diamond symbol, a heart symbol, a star, and a figure with a cross.

TRACK 6



VAMP THE MANSION





  #  # 

TRACK 7

BRAVE HEROES



 #  # 

   

★ ENCORE







 











★  # 













TRACK 7

BRING IT TO THE MAX

 1























 







 2







★ # 





1st ENCORE



★ 2nd ENCORE





TRACK 7

UNDERWORLD PREVIEW

Grid layout for Track 7:

- Row 1: 4 cards. Icons: radiation, star, location pin, location pin.
- Row 2: 1 card. Icon: heart.
- Row 3: 4 cards. Icons: diamond, heart, star, character icon.
- Row 4: 1 card. Icon: character icon.
- Row 5: 2 cards labeled '1st ENCORE' and '2nd ENCORE' with arrows pointing to them.

TRACK 8

METAL METRO MAYHEM

Grid layout for Track 8:

- Row 1: 2 cards. Icons: location pin, location pin.
- Row 2: 5 cards. Icons: heart, spade, star, character icon, radiation symbol.
- Row 3: 2 cards. Icons: none.
- Row 4: 2 cards. Icons: character icon, radiation symbol.
- Row 5: 2 cards labeled '1st ENCORE' and '2nd ENCORE' with arrows pointing to them.

TRACK 10

INTRODUCING THE HALL

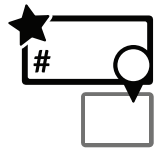

TRACK 10

MBRO AWARDS MEDLEY

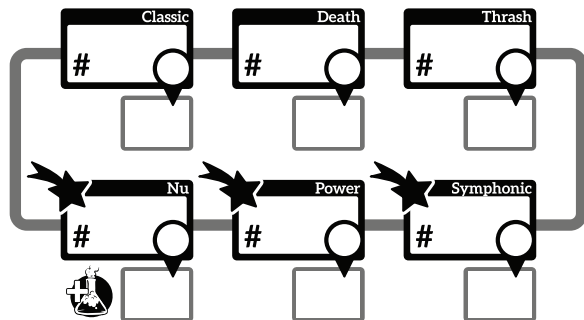

BONUS 3

ECHO ROSSIJA

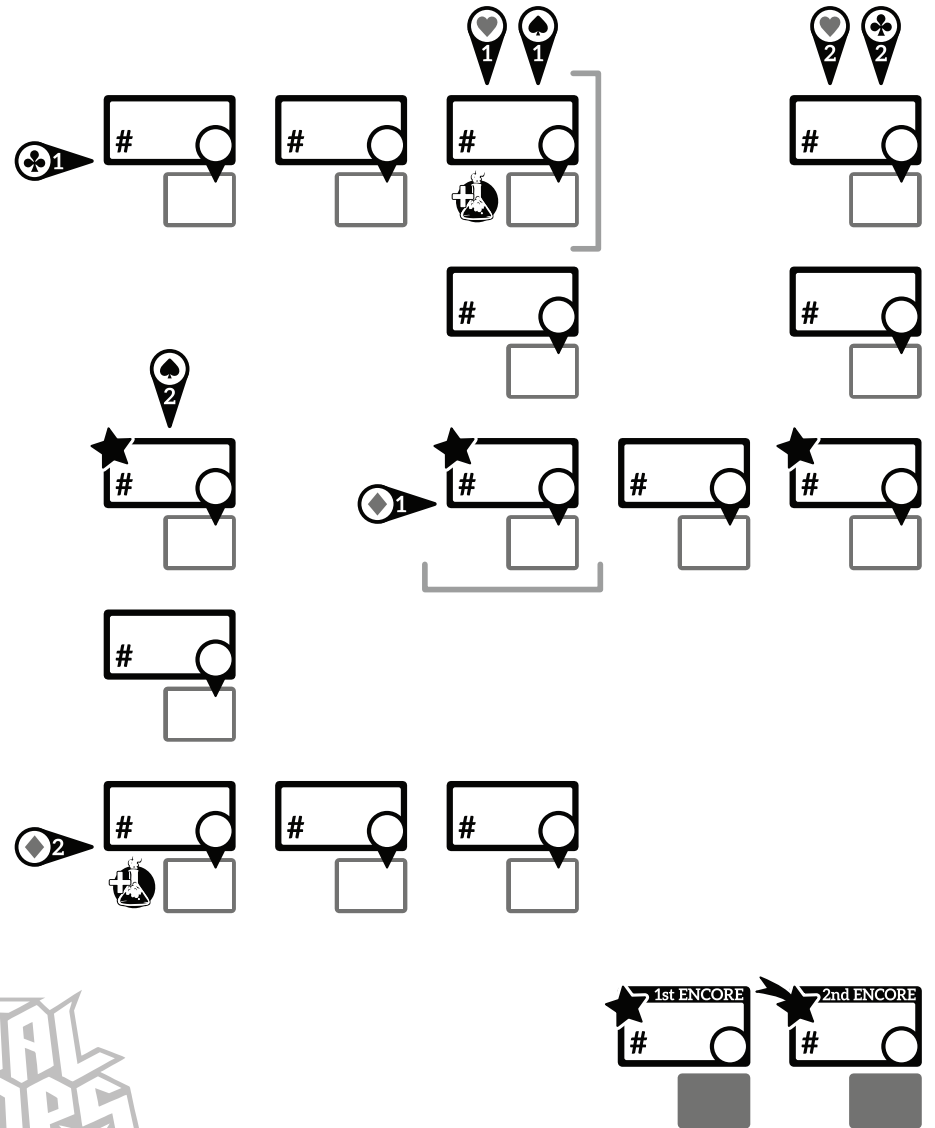

BONUS 3

SÃO PAULO ARENA



GIG GRIDS
PAGE 8

FINAL

INFERNO IN THE DEEP

Grid for São Paulo Arena with 5 columns and 6 rows of song slots. Each slot contains a '#' and a circle with a pin. Various icons and symbols are placed around the grid:

- Row 1: Slot 1 has a ♣️ 1 icon above; Slot 4 has a ★ icon above; Slot 5 has a ♠️ 2 icon above and a 🏠 icon below.
- Row 2: Slot 1 has a ♠️ 1 icon to the left; Slot 4 has a ★ icon above.
- Row 3: Slot 1 has a ♠️ 1 icon to the left; Slot 2 has a 🏠 icon below; Slot 3 has a ♣️ 2 icon to the left; Slot 4 has a ★ icon above.
- Row 4: Slot 1 has a ♠️ 1 icon to the left; Slot 2 has a 🏠 icon below.
- Row 5: Slot 1 has a ♠️ 1 icon to the left; Slot 5 has a ★ icon above.
- Row 6: Slot 1 has a ♠️ 2 icon to the left; Slot 5 has a 🏠 icon below.
- Row 7: Slot 1 is labeled '1st ENCORE' with a 🏠 icon below; Slot 2 is labeled '2nd ENCORE' with a ★ icon above and a 🏠 icon below; Slot 3 is labeled '3rd ENCORE' with a ★ icon above and a 🏠 icon below.

1ST SONG

1st Song slot: # [] with a 🏠 icon below.

1ST SET

1st Set slots: # [] with a Death icon above and a 🏠 icon below; # [] with a Death icon above and a 🏠 icon below.

2ND SET

2nd Set slots: # [] with a Thrash icon above and a 🏠 icon below; # [] with a Thrash icon above and a 🏠 icon below; # [] with a Thrash icon above and a 🏠 icon below.

FINAL SET

Final Set slots with numbered callouts:

- Slot 1: # [] with a 🏠 icon below and callout 11.
- Slot 2: # [] with a 🏠 icon below and callout 13.
- Slot 3: # [] with a 🏠 icon below and callout 12.
- Slot 4: # [] with a 🏠 icon below and callout 15.
- Slot 5: # [] with a 🏠 icon below and callout 12.
- Slot 6: # [] with a 🏠 icon below and callout 13.
- Slot 7: # [] with a 🏠 icon below and callout 14.
- Slot 8: # [] with a 🏠 icon below and callout 16.